

DYNAMIS

LITHIUM-LINE

Lithium Thionyl Chloride cells (Li/SOCl₂)

3,6 Volt Nominal Voltage – Temperature Range -55°C ~ +85°C



LITHIUM-LINE LI-100

- High Capacity
- For low current applications

Type	Size	nominal capacity	max.continuous discharge current	max. pulse discharge current	weight	pin-configuration
LI-110	ER14250 ½ AA	1'200 mAh	40 mA	100 mA	10 g	S/T/P/PT/PTV/EPR
LI-130	ER14505 AA	2'700 mAh	100 mA	200 mA	19 g	S/T/P/PT
LI-140	ER17505 A	3'400 mAh	120 mA	200 mA	24 g	S/T/P
LI-150	ER26500 C	8'500 mAh	130 mA	300 mA	53 g	S/T/P
LI-160	ET34615 D	19'000 mAh	230 mA	400 mA	105 g	S/T/P
LI-170	ER341215 DD	35'000 mAh	420 mA	500 mA	200 g	S/T/W

LITHIUM-LINE LI-200

- Spiral construction allows a higher discharge current
- Less weight

LI-210	ER14250 ½ AA	750 mAh	100 mA	300 mA	10 g	S/T/P/PT/PTV/EPR
LI-230	ER14505 AA	2'200 mAh	500 mA	1'000 mA	20 g	S/T/P/PT/PTV/EPR
LI-250	ER26500 C	6'500 mAh	1'000 mA	2'000 mA	56 g	S/T/P/W
LI-260	ER34615 D	13'000 mAh	2'000 mA	4.000 mA	110 g	S/T/P/W

Detailed technical information: see datasheets

Cells of **High-temperature serie LI-300** for project design-in are available upon request.

Sizes

LI-110 / LI-210
½ AA

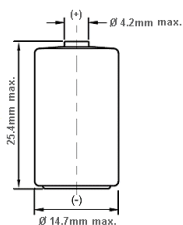

LI-130 / LI-230
AA

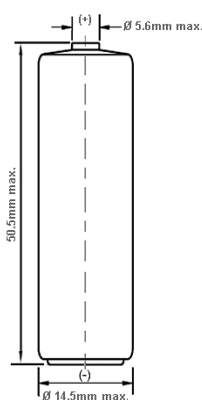

LI-140
A

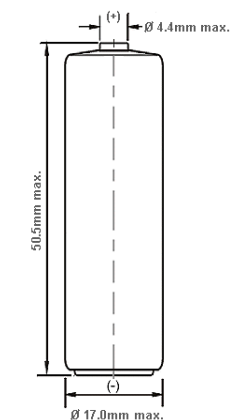

LI-150 / LI-250
C

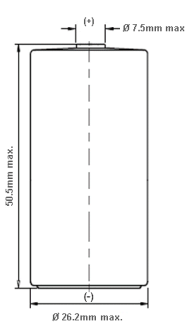

LI-160 / LI-260
D

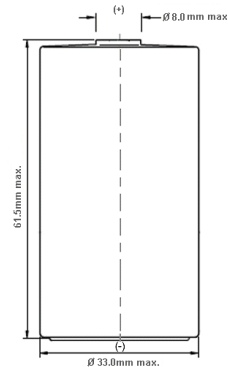

LI-170
DD

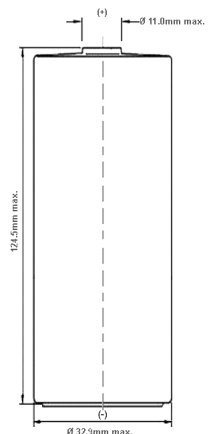

I
U
S
S
A

Possible tabs for Lithium cells

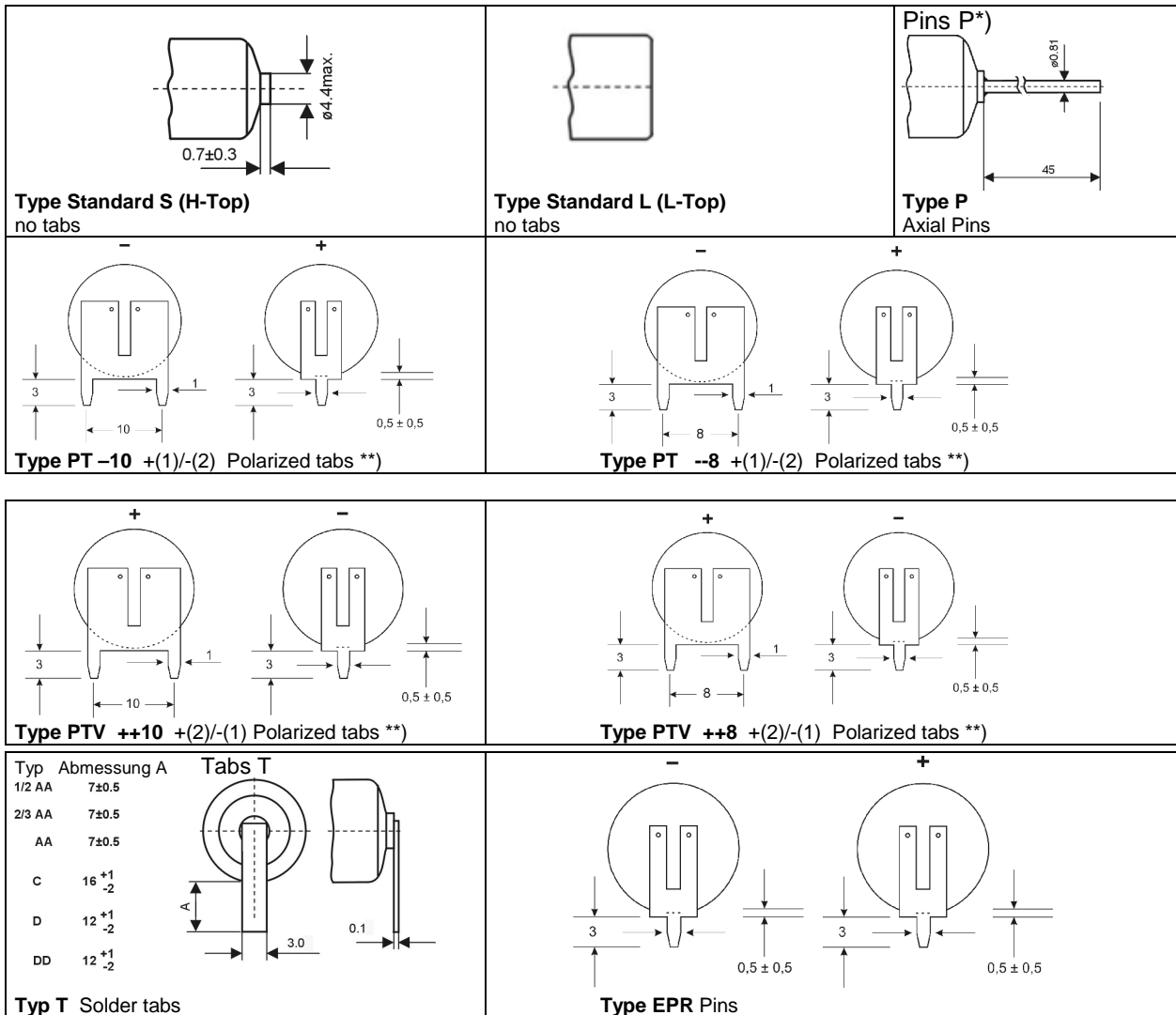

*) Please notice our Customer Information according to the processing of cells w/ axial pins (/P versions) next page.

**) available for sizes ½ AA, and AA only

*) Customer Information according processing of cells w/ axial pins (/P versions)

DYNAMIS Batterien GmbH recommends his customers to use special care during bending of the welded axial pins of Primary cells (where applicable). The pins may be damaged at the welding point if the distance to the bending point is too small. A minimum distance of 5 mm is recommended to avoid damages. In addition, we recommend the use of a supportive bending tool to sustain the bending point. If these recommendations are followed there is no limit for the angle of bending.

